



MATHIAS BÄUERLE

Mathias Bäuerle GmbH · Gewerbehallestr. 7-11 · D-78112 St.Georgen · Telefon: (07724) 882-0 · Telefax: (07724) 88 21 11

Drehstation TI 90 Turning Device TI 90

ERSATZTEILKATALOG SPARE PARTS CATALOG

Bearbeitungszeiten des beiliegenden "Notkatalogs MS 45"

29.01.1996: Techn. Dokumentation Fotos einscannen, bearbeiten, Satz, Layout: 5 Std.

von 29.01.96 Konstruktion Teilenummern eintragen
bis 22.02.96

22.02.96 Techn. Dokumentation Satz fertigstellen, korrigieren, 5 Exempl. : 3,5 Std.

INHALT / CONTENTS

Gruppe 1	5
Group 1	5
Gruppe 2	7
Group 2	7
Gruppe 3	9
Group 3	9
Gruppe 4	11
Group 4	11
Gruppe 5	13
Group 5	13
Gruppe 6	15
Group 6	15
Gruppe 7	17
Group 7	17
Gruppe 8	19
Group 8	19
Numerische Teileliste	20
Numerical Parts List	20

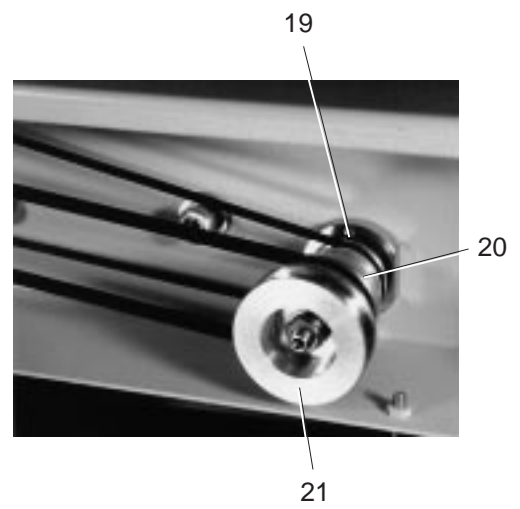
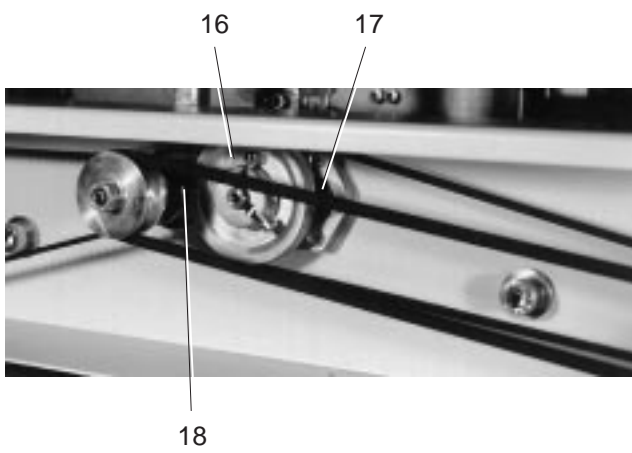
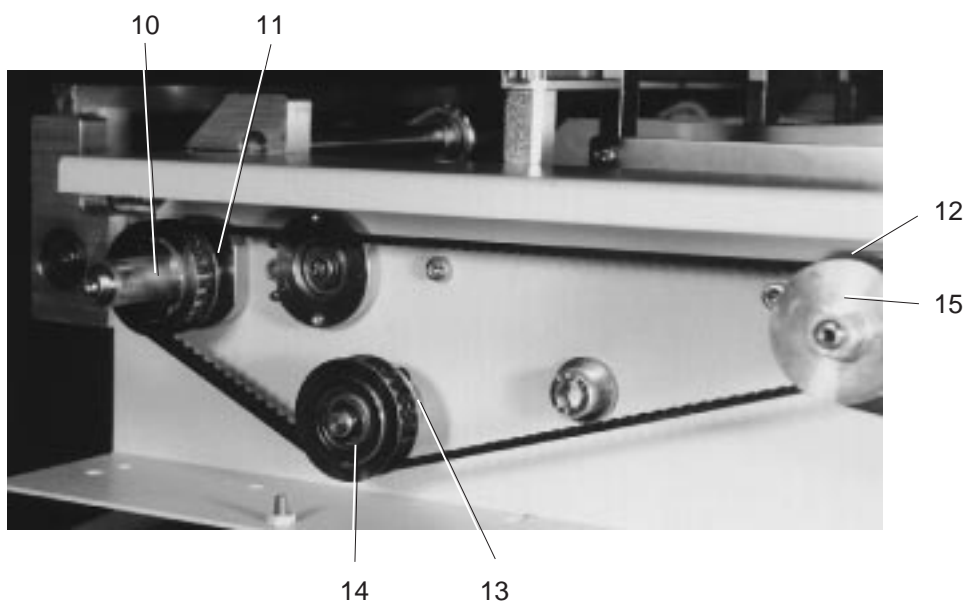
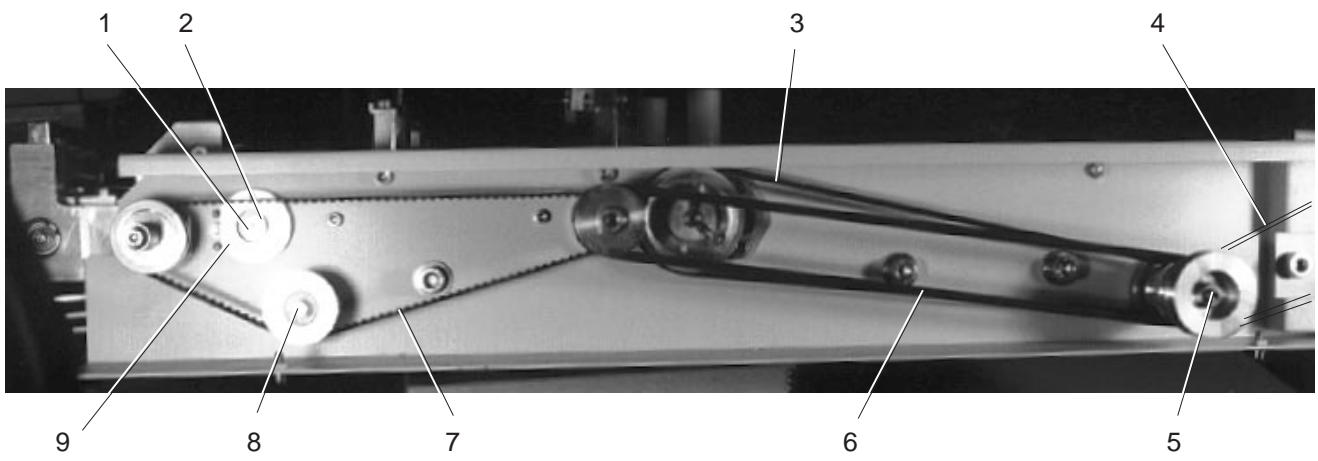

Gruppe 1
Group 1

Pos.	Teile-Nr.	Beschreibung	Qty.
Pos.	Part No.	Description	Qty.
1	2.017.186	Welle / Shaft	1
2	1.112.025	Lager / Bearing	2
3	1.033.131	Rundriemen / Round belt	1
4	1.033.094	Rundriemen / Round belt (6x597 mm)	1
5	2.017.251	Welle / Shaft	1
6	1.033.130	Rundriemen / Round belt (6x730 mm)	1
7	1.033.014	Zahnriemen / Timing belt	1
8	2.006.613	Bolzen / Bolt	1
9	2.012.734	Lagerflansch / Flange	2
10	4.005.237	Zahnriemenscheibe / Timing belt pulley	1
11	2.012.734	Lagerflansch / Flange	2
12	4.005.236	Zahnriemenscheibe / Timing belt pulley	1
13	1.112.030	Lager / Bearing	2
14	2.046.211	Zahnriemenscheibe / Timing belt pulley	1
15	2.012.793	Rundriemenscheibe / Round belt pulley	1
16	4.004.041	Rundriemenscheibe kpl. / Round belt pulley cpl.	1
	1.021.061	Rundriemenscheibe / Round belt pulley	1
	1.112.005	Lager / Bearing	1
17	4.004.539	Lager kpl. / Bearing cpl.	2
	1.112.005	Lager / Bearing	2
	1.021.063	Flansch / Flange	4
18	1.012.734	Flansch / Flange	2
	1.112.025	Lager / Bearing	2
19	1.112.025	Lager / Bearing	2
	2.012.734	Flansch / Flange	2
20	2.012.792	Rundriemenscheibe / Round belt pulley	1
21	2.012.791	Rundriemenscheibe / Round belt pulley	1

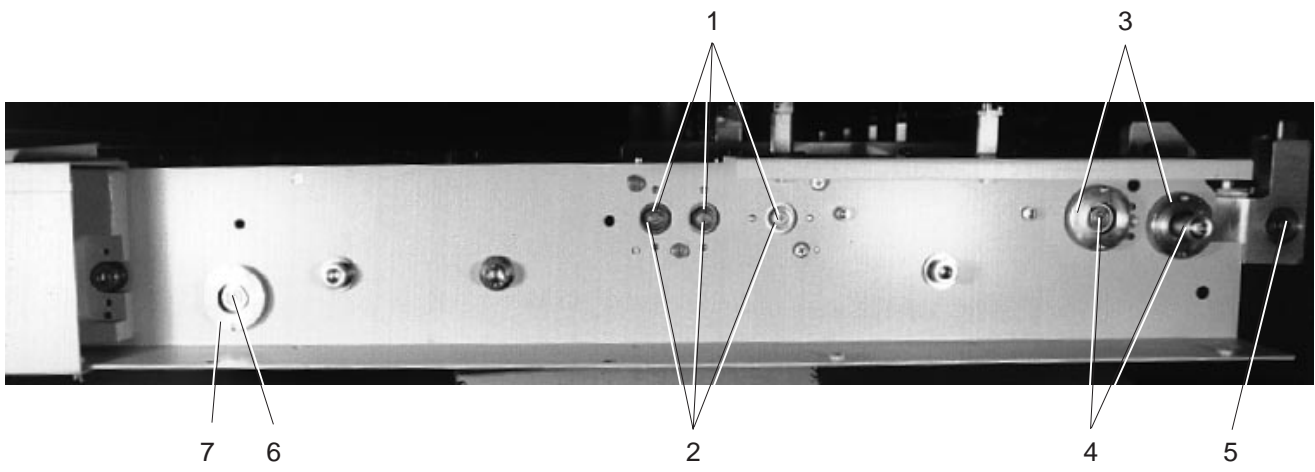

Gruppe 2
Group 2

Pos.	Teile-Nr.	Beschreibung	Qty.
Pos.	Part No.	Description	Qty.
1	4.004.529	Lager kpl. / Bearing cpl.	3
	1.112.005	Lager / Bearing	3
2	1.021.063	Flansch / Flange	3
3	2.012.734	Flansch / Flange	4
4	1.112.025	Lager / Bearing	4
5	1.112.025	Lager / Bearing	1
6	1.112.025	Lager / Bearing	2
7	2.012.734	Flansch / Flange	2

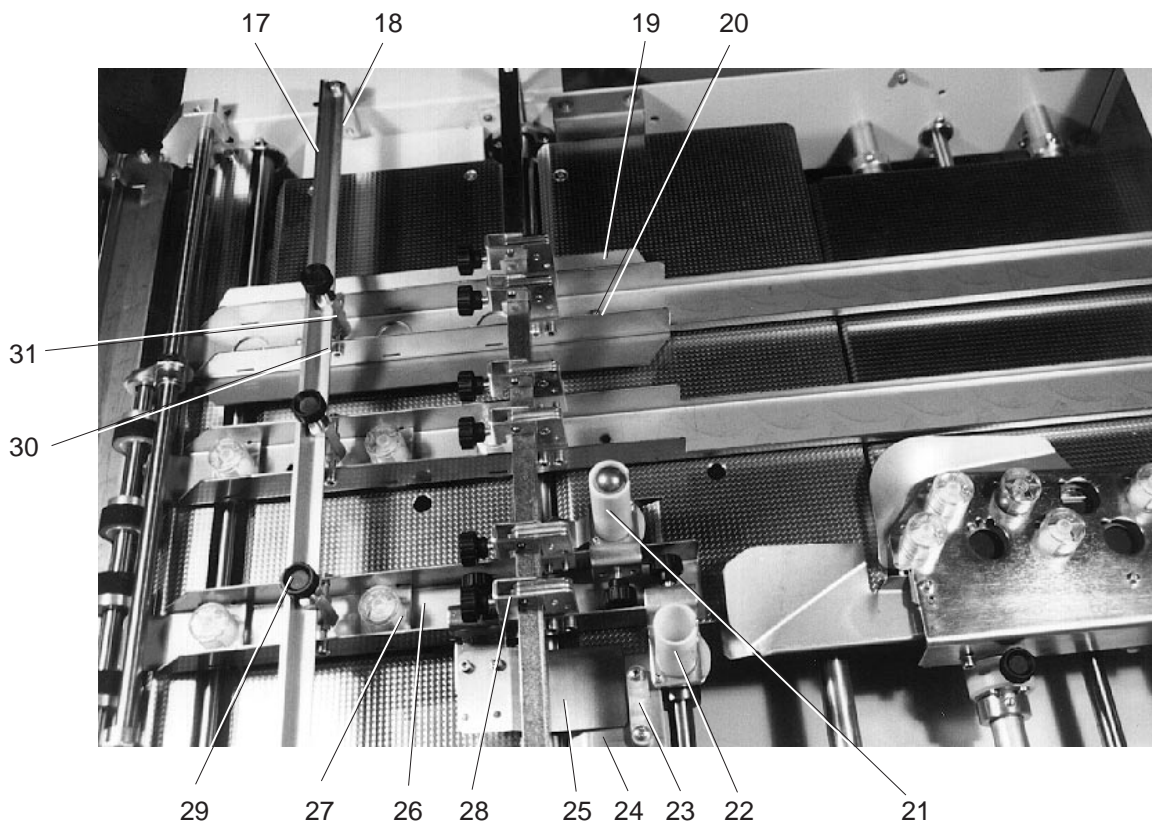
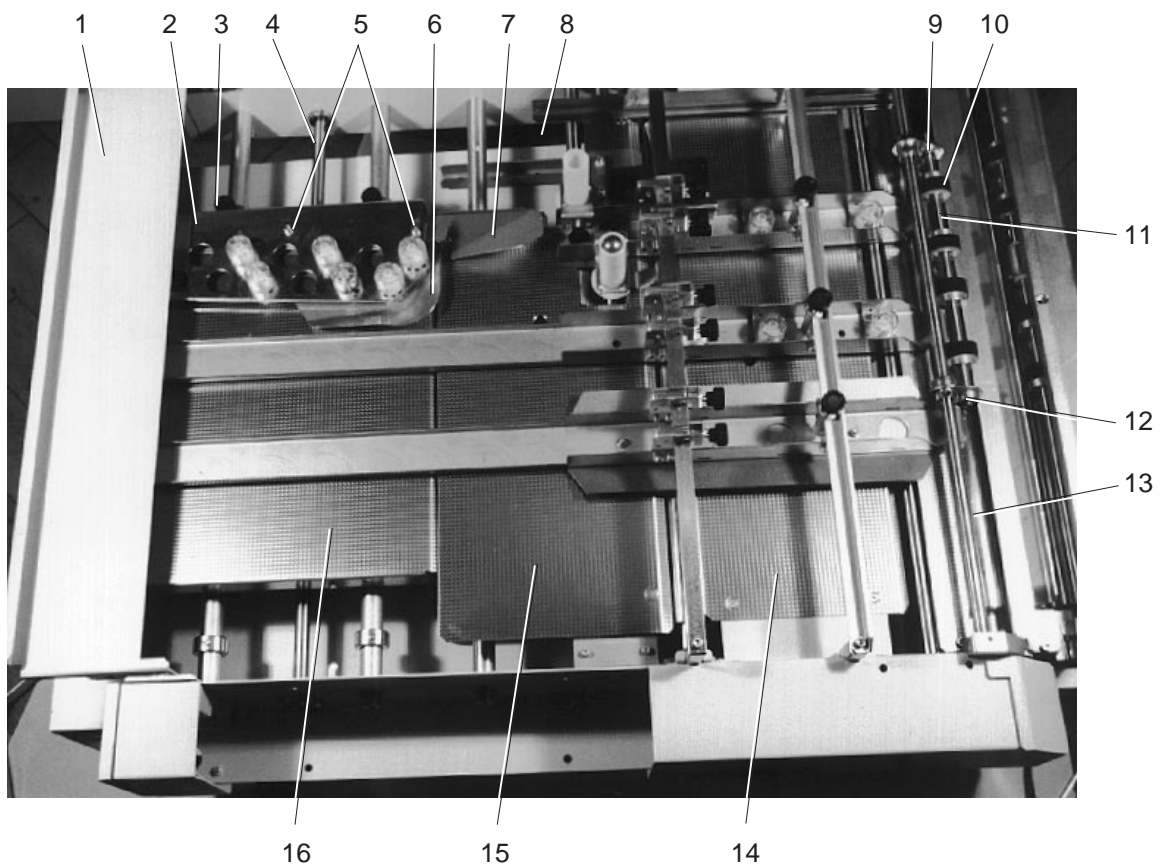

Gruppe 3 TI90/RD (rechtsdrehend)
Group 3 TI90/RD (right turning)

Pos.	Teile-Nr.	Beschreibung	Qty.
Pos.	Part No.	Description	Qty.
1	2.028.544	Schutz / Protective plate	1
2	2.028.813	Kugelhalter TI90/RD / Ball cage TI90/RD	1
	2.028.814	Kugelhalter TI90/LD / Ball cage TI90/LD	1
3	1.027.426	Rändelschraube / Knurled screw	2
4	2.017.251	Welle / Shaft	1
5	1.169.004	Schraube / Screw	2
6	2.029.361	Leitblech (rechts) / Paper guide (right)	1
	2.029.362	Leitblech (links) / Paper guide (left)	1
7	4.005.843	Anschlagblech (rechts) / Rail (right)	1
	4.005.821	Anschlagblech (links) / Rail (left)	1
8	4.006.681	Ausrichtschiene (rechts) / Alignment rail (right)	1
	4.006.682	Ausrichtschiene (links) / Alignment rail (left)	1
9	1.112.004	Lager / Bearing	2
10	4.002.556	Rolle / Roller	8
11	2.017.115	Welle / Shaft	1
12	4.005.200	Hebel / Lever	2
13	2.017.265	Walze / Roller	1
14	2.028.855	Leitblech / Plate	1
15	2.028.970	Leitblech (A4Q) / Plate (A4 landscape)	1
	2.028.971	Leitblech (A4L) / Plate (A4 portrait)	1
16	2.028.973	Leitblech (rechts) / Plate (right)	1
	2.028.972	Leitblech (rechts) / Plate (right)	1
	2.028.872	Leitblech (links) / Plate (left)	1
	2.028.871	Leitblech Rautenmuster (links) / Ripple plate (left)	1
17	2.051.631	Schiene / Rail	1
18	2.051.630	Halter / Bracket	2
	1.143.007	Schraube / Screw	2
19	2.029.749	Leitblech / Guide	1
20	1.123.001	SK-Mutter / Nut	2
21	1.017.561	Hülse / Sleeve	1
	2.028.404	Halterung / Bracket	1
	2.028.517	Verlängerung / Extension	1
22	1.017.561	Hülse / Sleeve	1
23	2.051.719	Anschlag / Paper stop	1
24	2.028.843	Leitblech / Paper guide	1
25	2.028.845	Leitblech / Paper guide	1
26	2.029.516	Schiene / Guide	1
27	2.022.826	Platte / Plate	5
28	4.006.007	Halter / Bracket	7
29	1.027.426	Rändelschraube / Knurled screw	9
30	1.143.006	Schraube / Screw	6
31	2.051.633	Halter / Bracket	4

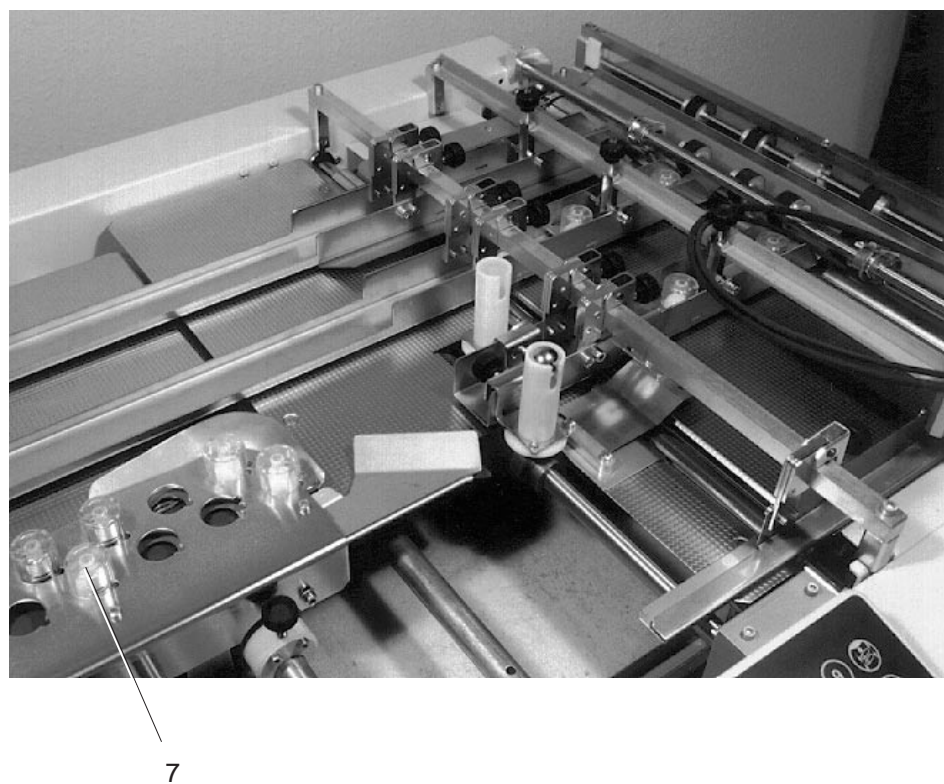
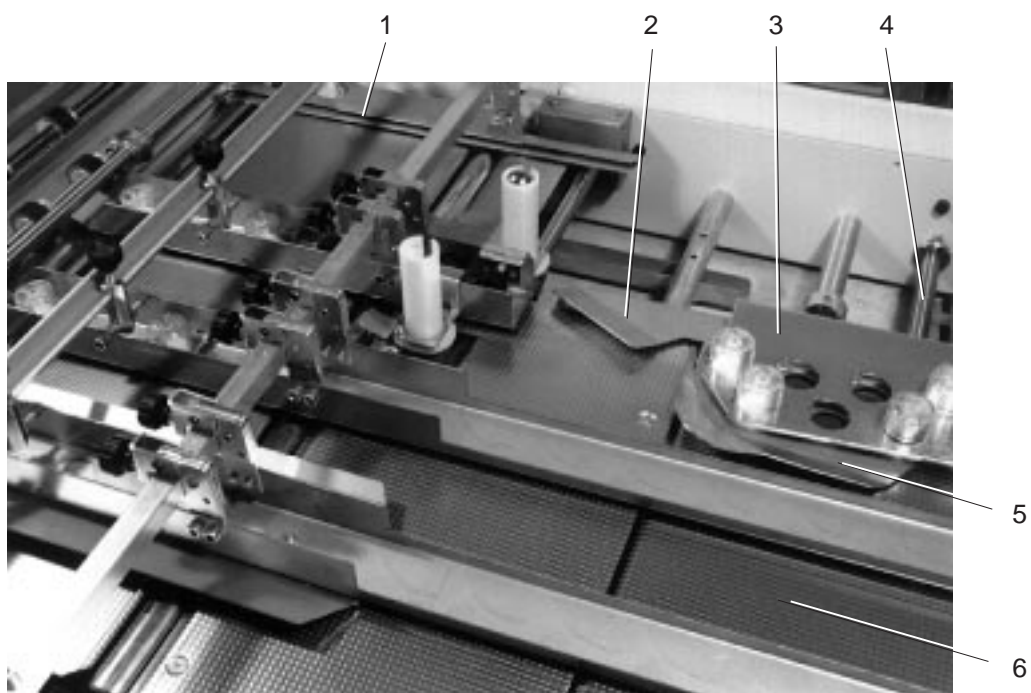

Gruppe 4
Group 4

Pos.	Teile-Nr.	Beschreibung	Qty.
Pos.	Part No.	Description	Qty.
1	4.006.682	Anschlag (links) kpl. / Rail (left) cpl.	1
	2.028.839	Anschlag (links) / Rail (left)	1
2	4.005.821	Anschlagblech (links) / Stop (left)	1
3	2.028.814	Kugelhalter / Ball cage	1
4	2.017.251	Welle / Shaft	1
5	2.029.362	Leitblech / Guide	1
6	2.028.872	Leitblech (links) / Plate (left)	1
	2.028.871	Leitblech Rautenmuster (links) / Ripple plate (left)	1
7	1.017.526	Kugelkäfig / Ball cage	16
	5.616.003	Kugel Stahl / Ball steel	8
	5.616.002	Kugel Kunststoff / Ball plastic	8

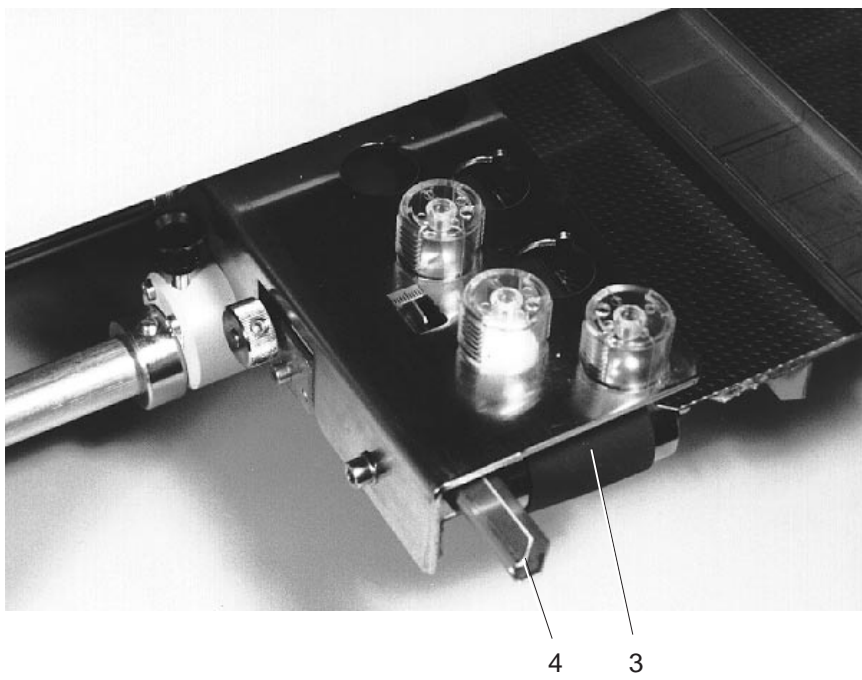
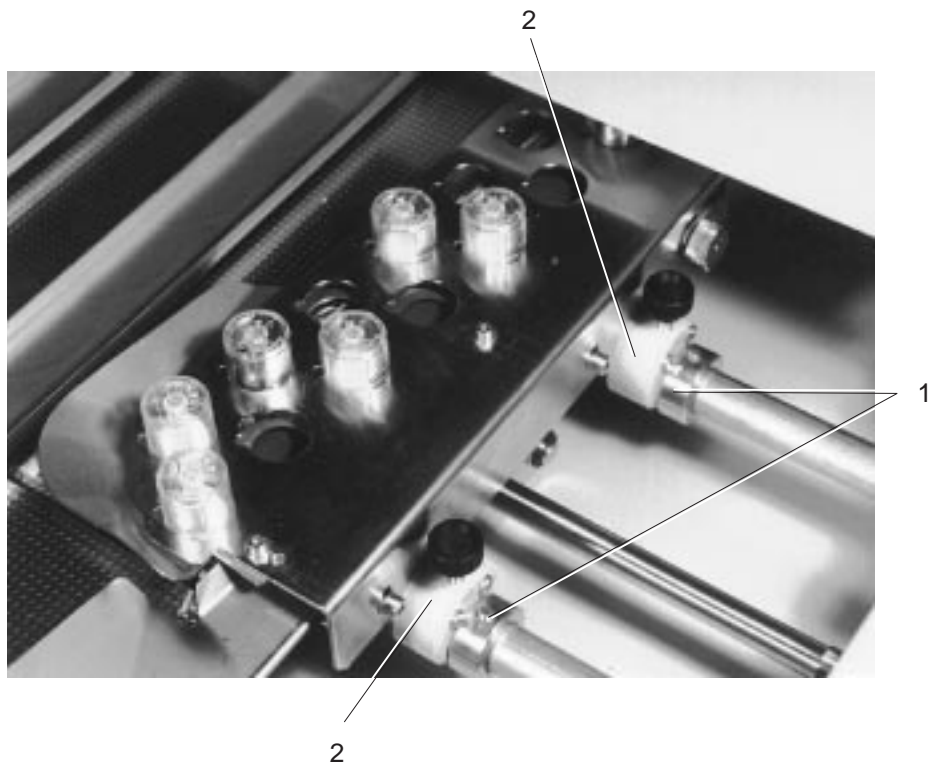

Gruppe 5
Group 5

Pos.	Teile-Nr.	Beschreibung	Qty.
Pos.	Part No.	Description	Qty.
1	1.220.001	Stellring / Collar	2
2	2.012.911	Exzenterbuchse / Eccentric bushing	2
3	1.031.100	Flachriemen / Flat belt	1
4	4.005.843	Anschlagblech (rechts) / Rail (right)	1
5	4.005.821	Anschlagblech (links) / Rail (left)	1

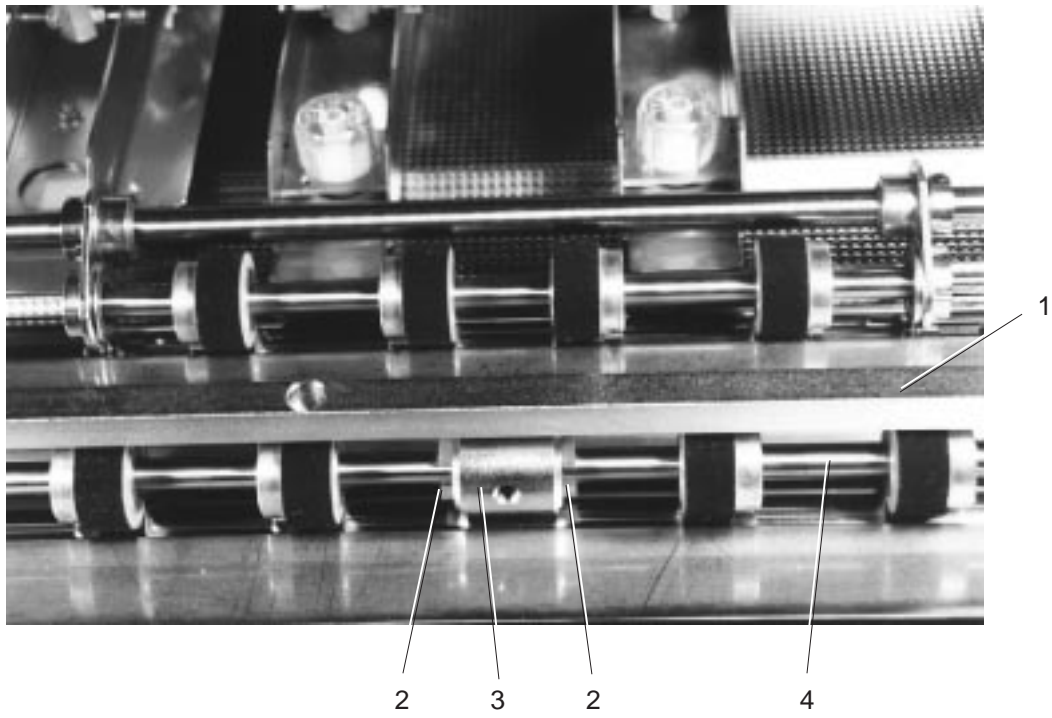

Gruppe 6
Group 6

Pos.	Teile-Nr.	Beschreibung	Qty.
Pos.	Part No.	Description	Qty.
1	2.051.695	Stange / Bar	1
2	1.027.480	Achsenklemmring (rot) / C-clip (red)	2
3	2.001.455	Buchse / Bushing	1
4	2.017.303	Achse / Shaft	1
-	4.006.394	Bausatz angef. Rollen / Kit spring loaded roller	1

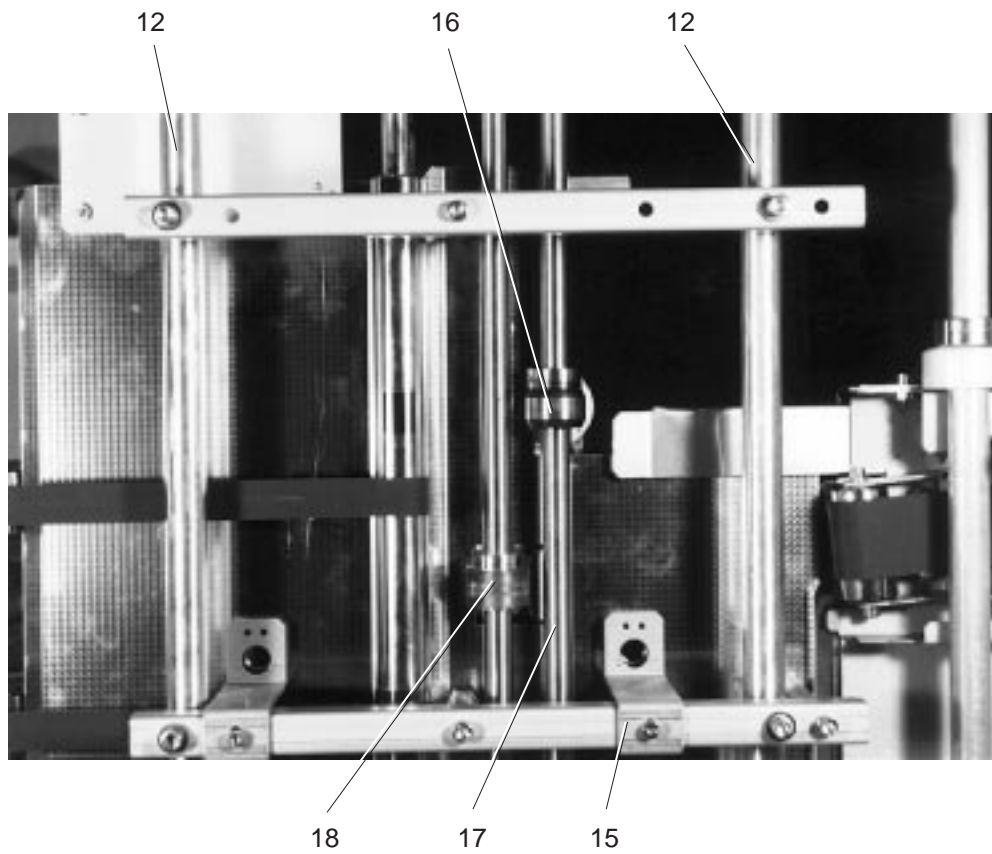
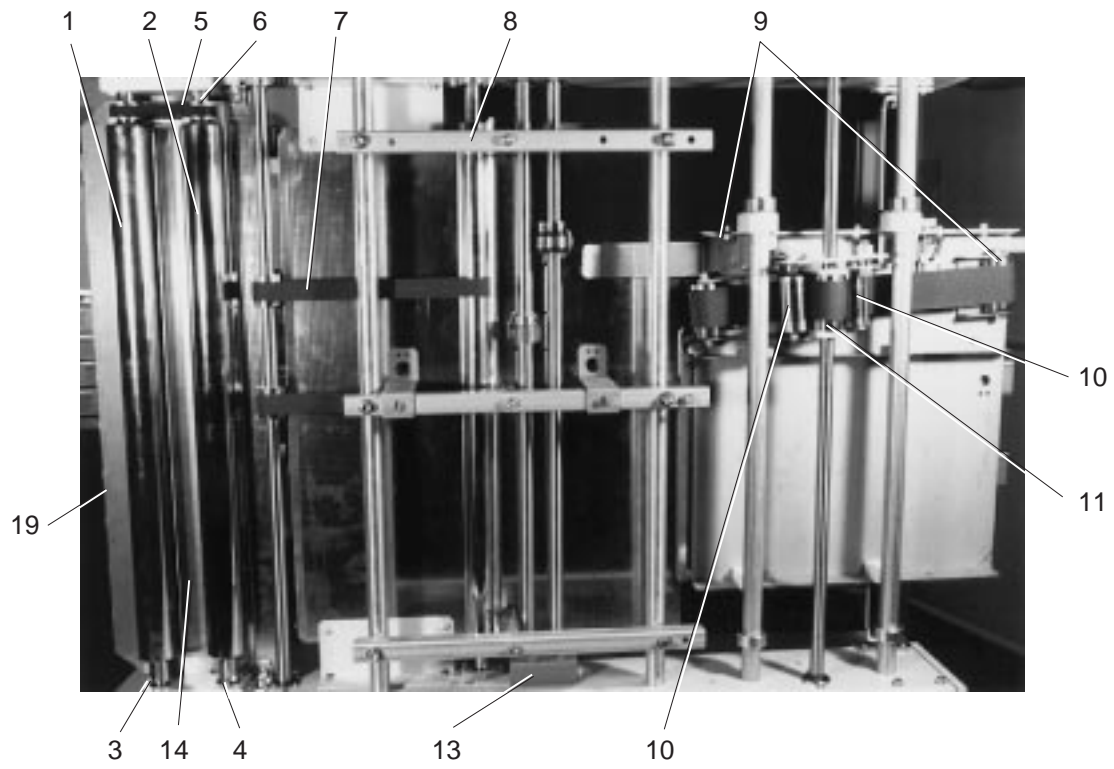

Gruppe 7
Group 7

Pos.	Teile-Nr.	Beschreibung	Qty.
Pos.	Part No.	Description	Qty.
1	2.017.255	Walze / Roller	1
2	2.017.265	Walze / Roller	1
3	1.112.025	Lager / Bearing	2
4	1.112.025	Lager / Bearing	
5	1.033.077	Zahnriemen / Timing belt	1
6		Zahnriemenrad / Timing belt pulley	2
7	1.031.102	Flachriemen / Flat belt	1
8	2.028.967	Schiene / Bar	3
9	4.005.202	Rolle kpl. / Roller cpl.	2
	2.012.741	Rolle / Pulley	2
	1.112.005	Lager / Bearing	8
10	4.005.201	Rolle kpl. / Roller cpl.	2
	2.012.739	Rolle / Pulley	2
11	4.005.203	Rolle kpl. / Roller cpl.	1
	2.012.740	Rolle / Pulley	1
	1.052.030	Freilauf / Idler	2
12	2.017.187	Achse / Shaft	2
13	2.028.844	Abdeckung / Cover	1
14	2.028.558	Leitbleche / Paper guides	2
15	2.029.024	Bügel / Bracket	2
16	2.012.783	Rolle / Roller	1
17	2.017.292	Welle / Shaft	1
18	4.001.294	Buchse / Bushing	1
19	4.005.877	Führungsblech / Paper guide	1

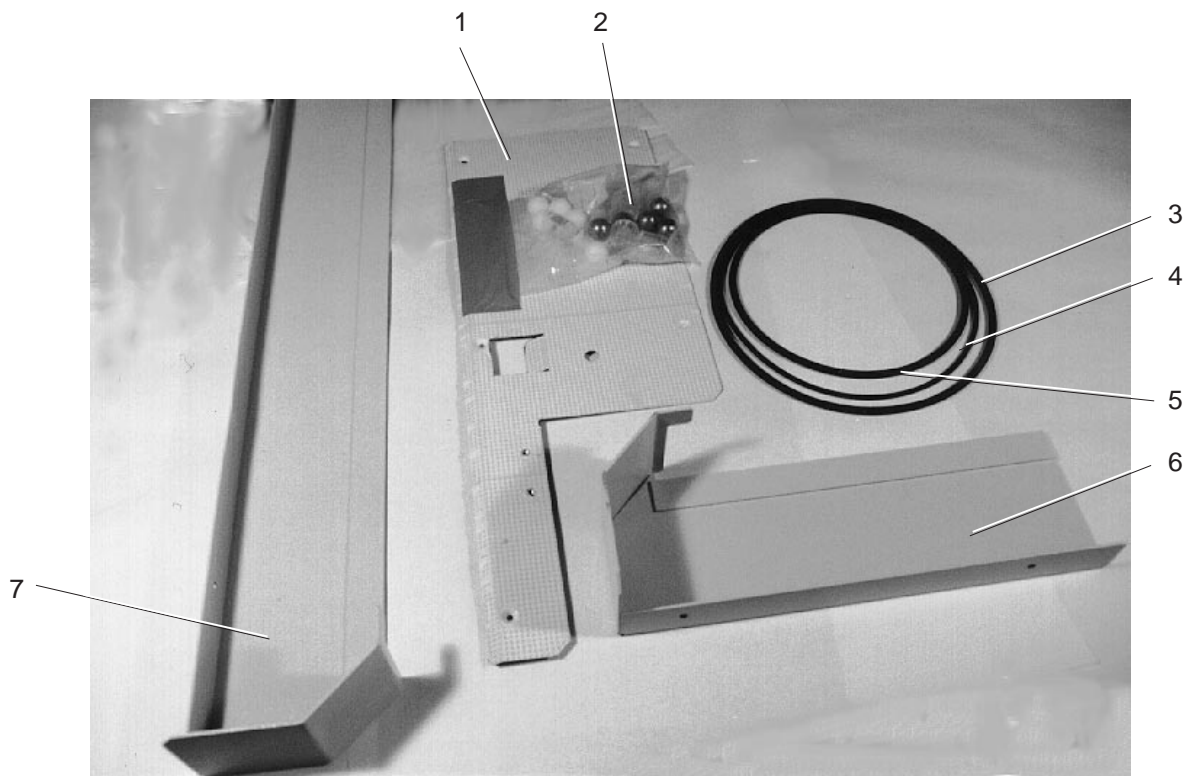

Gruppe 8
Group 8

Pos.	Teile-Nr.	Beschreibung	Qty.
Pos.	Part No.	Description	Qty.
1	2.028.971	Blech 0° / Plate	1
2	5.616.003	Kugel Stahl / Ball steel	7
	5.616.002	Kugel Kunststoff / Ball plastic	7
	1.017.526	Kugelkäfig / Ball cage	7
3	1.033.031	Rundriemen / Round belt	1
4	1.033.094	Rundriemen / Round belt	1
5	1.033.130	Rundriemen / Round belt	1
6	4.005.785	Abdeckung / Cover	1
7	4.005.784	Abdeckung / Cover	1

Numerische Teileliste

Numerical Parts List

Teile-Nr. Part No.	Beschreibung Description	Grp. Grp.
1.033.094	Rundriemen / Round belt (6x597 mm)	1
1.033.130	Rundriemen / Round belt (6x730 mm)	1
	Zahnriemenrad / Timing belt pulley	7
1.012.734	Flansch / Flange	1
1.017.526	Kugelkäfig / Ball cage	4
1.017.526	Kugelkäfig / Ball cage	8
1.017.561	Hülse / Sleeve	3
1.021.061	Rundriemenscheibe / Round belt pulley	1
1.021.063	Flansch / Flange	1
1.021.063	Flansch / Flange	2
1.027.426	Rändelschraube / Knurled screw	3
1.027.480	Achsenklemmring (rot) / C-clip (red)	6
1.031.100	Flachriemen / Flat belt	5
1.031.102	Flachriemen / Flat belt	7
1.033.014	Zahnriemen / Timing belt	1
1.033.031	Rundriemen / Round belt	8
1.033.077	Zahnriemen / Timing belt	7
1.033.094	Rundriemen / Round belt	8
1.033.130	Rundriemen / Round belt	8
1.033.131	Rundriemen / Round belt	1
1.052.030	Freilauf / Idler	7
1.112.005	Lager / Bearing	1
1.112.005	Lager / Bearing	2
1.112.005	Lager / Bearing	3
1.112.005	Lager / Bearing	7
1.112.030	Lager / Bearing	1
1.123.001	SK-Mutter / Nut	3
1.143.006	Schraube / Screw	3
1.143.007	Schraube / Screw	3
1.143.054	Schraube / Screw	3
1.169.004	Schraube / Screw	3
1.169.010	Linsenschraube / Screw	3
1.220.001	Stellring / Collar	5
2.001.455	Buchse / Bushing	6
2.006.613	Bolzen / Bolt	1
2.011.557	Buchse / Bushing	7
2.012.734	Lagerflansch / Bearing flange	1
2.012.734	Lagerflansch / Bearing flange	2

Teile-Nr. Part No.	Beschreibung Description	Grp. Grp.
2.012.739	Rolle / Pulley	7
2.012.740	Rolle / Pulley	7
2.012.741	Rolle / Pulley	7
2.012.783	Rolle / Roller	7
2.012.791	Rundriemenscheibe / Round belt pulley	1
2.012.792	Rundriemenscheibe / Round belt pulley	1
2.012.793	Rundriemenscheibe / Round belt pulley	1
2.012.911	Exzenterbuchse / Eccentric bushing	5
2.017.115	Welle / Shaft	3
2.017.186	Welle / Shaft	1
2.017.187	Achse / Shaft	7
2.017.251	Welle / Shaft	1
2.017.251	Welle / Shaft	3
2.017.251	Welle / Shaft	4
2.017.255	Walze / Roller	7
2.017.265	Walze / Roller	3
2.017.265	Walze / Roller	7
2.017.292	Welle / Shaft	7
2.017.303	Achse / Shaft	6
2.022.826	Platte / Plate	3
2.028.404	Halterung / Bracket	3
2.028.517	Verlängerung / Extension	3
2.028.544	Schutz / Protective Plate	3
2.028.558	Leitbleche / Paper guides	7
2.028.813	Kugelhalter TI90 RD / Ball cage TI90 RD	3
2.028.814	Kugelhalter TI90 LD / Ball cage TI90 LD	3
2.028.814	Kugelhalter TI90 LD / Ball cage TI90 LD	4
2.028.839	Anschlag links / Rail left	4
2.028.843	Leitblech / Paper guide	3
2.028.845	Leitblech / Paper guide	3
2.028.971	Blech 0° / Plate	8
2.028.844	Abdeckung / Cover	7
2.028.855	Leitblech / Plate	3
2.028.871	Leitblech Rautenmuster links / Ripple plate left	3
2.028.871	Leitblech Rautenmuster links / Ripple plate left	4
2.028.872	Leitblech links / Plate left	3
2.028.872	Leitblech links / Plate left	4
2.028.970	Leitblech (A4Q) / Plate (A4 landscape)	3
2.028.971	Leitblech (A4L) / Plate (A4 portrait)	3
2.028.967	Schiene / Bar	7
2.028.972	Leitblech rechts / Plate right	3
2.028.973	Leitblech rechts / Plate right	3

Teile-Nr. Part No.	Beschreibung Description	Grp. Grp.
2.029.024	Bügel / Bracket	7
2.029.361	Leitblech rechts / Paper guide right	3
2.029.362	Leitblech links / Paper guide left	3
2.029.362	Leitblech links / Paper guide left	4
2.029.516	Schiene / Guide	3
2.029.749	Leitblech / Guide	3
2.046.211	Zahnriemenscheibe / Timing belt pulley	1
2.051.630	Halter / Bracket	3
2.051.631	Schiene / Rail	3
2.051.633	Halter / Bracket	3
2.051.695	Stange / Bar	6
2.051.719	Anschlag / Paper stop	3
4.002.556	Rolle / Roller	3
4.004.541	Rundriemenscheibe kpl. / Round belt pulley cpl.	1
4.004.539	Lager kpl. / Bearing cpl.	1
4.004.539	Lager kpl. / Bearing cpl.	2
4.005.200	Hebel / Lever	3
4.005.201	Rolle kpl. / Roller cpl.	7
4.005.202	Rolle kpl. / Roller cpl.	7
4.005.203	Rolle kpl. / Roller cpl.	7
4.005.236	Zahnriemenscheibe / Timing belt pulley	1
4.005.237	Zahnriemenscheibe / Timing belt pulley	1
4.005.784	Abdeckung / Cover	8
4.005.785	Abdeckung / Cover	8
4.005.821	Anschlagblech links / Rail left	3
4.005.821	Anschlagblech links / Rail left	4
4.005.821	Anschlagblech links / Rail left	5
4.005.843	Anschlagblech rechts / Rail right	3
4.005.843	Anschlagblech rechts / Rail right	5
4.005.877	Führungsblech / Paper guide	7
4.006.007	Halter / Bracket	3
4.006.394	Bausatz angef. Rollen / Kit spring loaded roller	6
4.006.681	Ausrichtschiene rechts / Alignment rail right	3
4.006.482	Ausrichtschiene links / Alignment rail left	3
4.006.682	Ausrichtschiene links / Alignment rail left	4
5.616.002	Kugel Kunststoff / Ball plastic	4
5.616.002	Kugel Kunststoff / Ball plastic	8
5.616.003	Kugel Stahl / Ball steel	4
5.616.003	Kugel Stahl / Ball steel	8